



INSTALLATION INSTRUCTIONS

72" & 24" Slat Fence Kits

Please read entire instruction sheet before you begin.

Follow these instructions and recommendations to install posts and frames within warranty, and to avoid product damage.

Suitable for pro builders and DIY crafters.

Illustrations not to scale. Black posts and channels rendered in gray.

PLEASE READ INSTRUCTIONS COMPLETELY BEFORE YOU BEGIN: We recommend following best building practices for installing OUTDECO USA Steel Posts and Frames. Examples shown in this document are installation suggestions. Adjust installation configurations to meet your specific project requirements. If in doubt, consult a professional. We recommend checking with proper authorities about building codes/standards that may apply to your project. The OUTDECO USA Post & Frame System has a **5-Year Limited Warranty** for material integrity when installed per these instructions. Installers assume responsibility for the installation (See page 4).

System Components & Features

Frame Channels

- Two Slat Fence Kit sizes for:
 - 72" total slat heights (Fig. 1)
 - 24" total slat heights (Fig. 2)
- Channels adjust for slats 1/2" to 1" thick.
- Channel slots directly align with pre-drilled holes on OUTDECO posts (Figs. 1 & 2).
- Channels can attach to existing walls, fences, and other flat surfaces (Fig. 3).

Slat Spacers

- Weather-resistant poly Slat Spacers create consistent 1/2" spacing between slats without measuring (Fig. 4).
- Stack Spacers for additional spacing between slats in 1/2" increments (Fig. 4; also see Fig. 11 on p. 2).

Optional Brace Strap - 72" Slat Kits

- Helps prevent slats warping or twisting. Recommended for slats less than 3/4" thick and/or low-grade woods. (See "Slat Materials" section on p. 2)

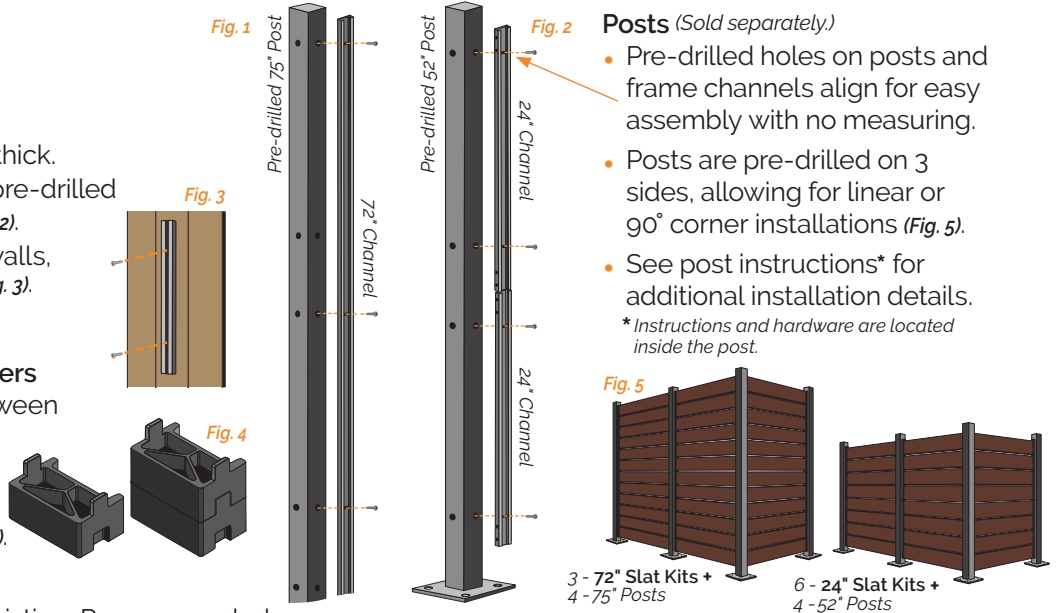

Posts (Sold separately)

- Pre-drilled holes on posts and frame channels align for easy assembly with no measuring.
- Posts are pre-drilled on 3 sides, allowing for linear or 90° corner installations (Fig. 5).
- See post instructions* for additional installation details.

* Instructions and hardware are located inside the post.

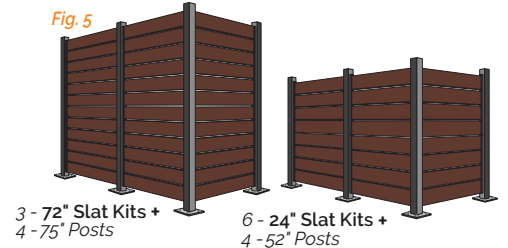

What's in the Box

24" Slat Fence Kit

QTY.	ITEM
2	24" Channel Sets (Channel pieces are labeled.)
4	Channel Screws - #8 x 1" Phillips
8	Slat Locking Screws - #6 x 7/8" Phillips
8	Poly Slat Spacers* - 1/2"H
1	Drill Bit - 1/8"

* Add additional spacers to increase spaces between slats in 1/2" increments. Packs of 24 spacers are sold separately.

72" Slat Fence Kit

QTY.	ITEM
2	72" Channel Sets (Channel pieces are labeled.)
8	Channel Screws - #8 x 1" Phillips
8	Slat Locking Screws - #6 x 7/8" Phillips
24	Poly Slat Spacers* - 1/2"H
1	Drill Bit - 1/8"
1	Optional Brace Strap
6	Brace Strap Screws - #8 x 1/4" Phillips

Posts

75"	52"	96"	ITEM
4	4	-	Wood Post Screws & Washers
4	4	-	Masonry Post Screws
1	1	1	Poly Post Cap
12	8	12	Poly Post Hole Plugs

NOTE: Hardware & instructions are located inside the post.

What You'll Need

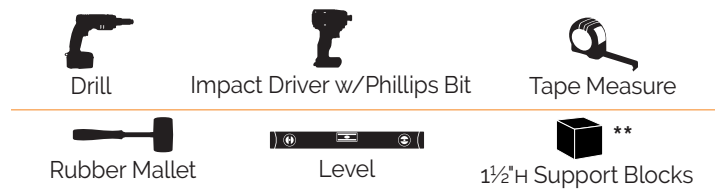

** Cardboard blocks are included in the kits, but wood blocks are recommended.

Plan Your Slat Design & Fence Configuration Read this entire section before planning your project.

BASIC FENCE CONFIGURATIONS & SHOPPING LIST

- **Slat Fence Kits** (per section of fencing):
 - 1 - 72" Slat Kit (Fig. 6) or
 - 2 - 24" Slat Kits (Fig. 7)
- **Wood or synthetic fence slats:**
 - **Slat Height:** 2" to 8" h
 - **Slat Depth:** ½" to 1" thick
 - **Slat Width:** max. 72" w
- **Posts** (sold separately):
 - 2 - 75" Posts (Fig. 6) or
 - 2 - 52" Posts (Fig. 7)
 - 1 additional Post for each Fence Kit added to your fence (Fig. 8 & 9)
- Additional spacers (sold separately) if your slats are less than 6" in height, or if you vary slat heights or slat spacing (Figs. 10 & 11)

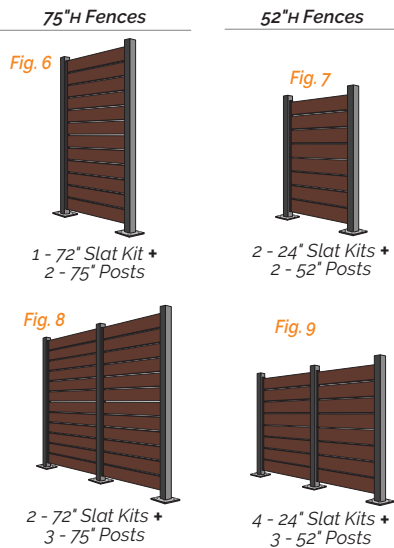

FENCE LOCATION – IMPORTANT!

Installing fencing under eaves, patio covers, pergolas, etc., **requires clear space deeper than your slat height above the posts** in order to insert the slats.

SLAT MATERIALS

- Slats should be at least ¾" thick and no wider than 72" to avoid bowing or warping.
- Recommend hardwoods such as tropical hardwood, cedar, and good-quality redwood. Consult a lumber merchant with knowledge about the aesthetics, durability, and weathering of fencing woods.
- If your slats are low-grade wood or less than ¾" thick, attach the optional Brace Strap* to help avoiding warping or twisting.
- Synthetic fence slats are also an option.

* Included with 72" Slat Kits. See Step #8 on page 4.

SLAT SIZING, SPACING & COMBOS

Vary slat heights or spacing, or add decorative panels, to create unique designs. Mix different slat heights plus spacers to add up to max. 72" (Fig. 10). Slat spacers are ½" h. Add spacers* to increase spacing in ½" increments (Fig. 11). Add Design-Vu or Modinex Panels for a look that reflects a myriad of styles (Fig. 12). Find other design ideas at design-vu.com/design-gallery and modinexpansels.com/design-gallery. Recommended slat widths are from 36" to max. 72" (Fig. 13). Slats wider than 72" may bow or warp.

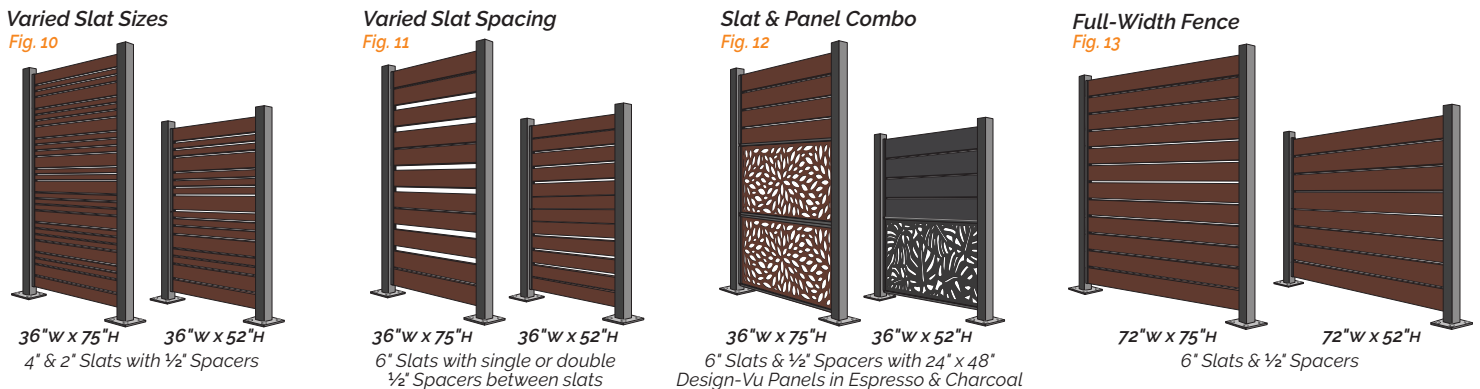

72" & 24" Slat Fence Kit

1. Install 1st Post

- Insert Post Caps on top of posts (included with posts).
 - Posts are drilled on 3 sides. Position the undrilled side as the front of your fence.
 - Install **1st Post only** to concrete or wood surface. Check that post is straight and bolt down with the 4 post screws* (Fig. 14).
 - Position 2nd post the approx. width of your slats from the 1st post. **Do not attach to surface** (Fig. 14).
 - For 96" In-Ground Post installations, see post installation instructions.
- * Masonry and wood screws are included with posts.

PRO TIP
 If needed, add shims under post plate to level.

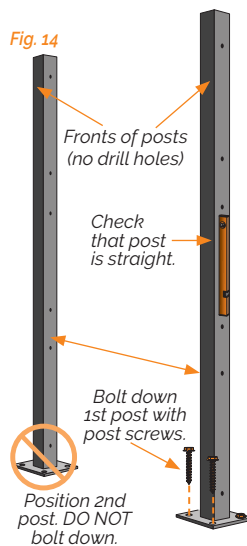

72" & 24" Slat Fence Kit

2. IMPORTANT! Identify Channels

Slat Kits contain two different sets of channels with identifying labels:

- A-Channel FRONT & A-Channel BACK (Fig. 15)
- B-Channel FRONT & B-Channel BACK (Fig. 16)
- Labels also indicate channels' TOP ends.

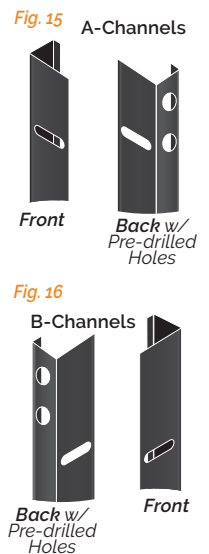

72" & 24" Slat Fence Kit

3. Attach Slat Channels to Posts

- Face the front of your posts. **A-Channels mount to the post to your right and B-Channels on post to your left** (Fig. 17).

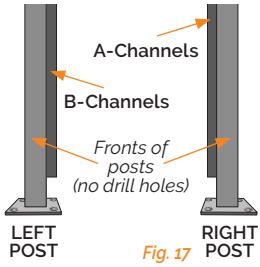

Attach Channels to Posts

following these specific directions:

- Place **A-Channel FRONT** on **RIGHT** post (Fig. 18). Place **A-Channel BACK** inside **A-Channel FRONT** (Fig. 19), aligning both channels slots.
- Using an impact driver, **loosely** drive a **Channel Screw** through top slots of both channels into post holes. Repeat in all other slots (Fig. 21 or 22).
- Repeat to attach the **B-Channels** to the **LEFT** post.
- Do not tighten screws yet.**

Channel Orientation

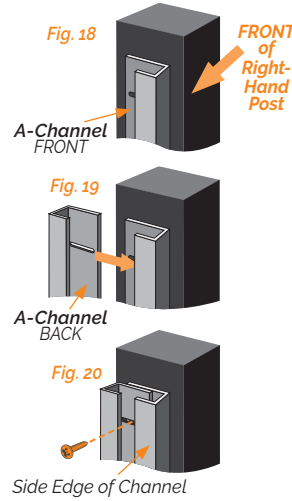

72" Slat Kit



72" & 24" Slat Fence Kit

4. Adjust Channel Widths

- Set 1½" blocks between posts.
- Temporarily insert a slat or scrap into channels (Fig. 23), and check that slat and posts are level.
- Adjust channels to **slat thickness plus 1/8"**. Slat should slide easily into channels. (Fig. 24).
- Drive in screws securely. **Do not overtighten.**

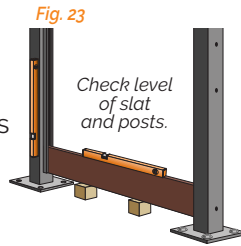

PRO TIP

Get the correct channel spacing by sliding a piece of the kit's packaging cardboard into the channel with the slat.

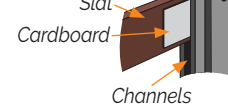
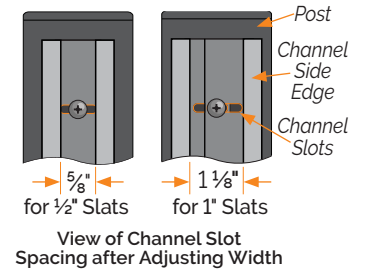

Fig. 24



72" & 24" Slat Fence Kit

5. Secure 1st Slat

Insert bottom slat and lock in place.

- Position bottom of slat flush with bottom of channel. Level slat.
 - Using included bit, pre-drill* into slat through holes in back of channel (Fig. 25).
 - Drive **Slat Locking Screws** into back of slat through channel holes (Fig. 26).
- * Do not drill all the way through the slat.

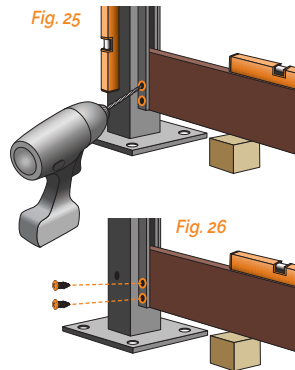

72" & 24" Slat Fence Kit

6. Install 2nd Post

- Width of installed slats determines location of 2nd post.
- Check that channels and posts are level to finalize accurate post placement.
- Bolt down with post screws (Fig. 27). Remove support blocks.

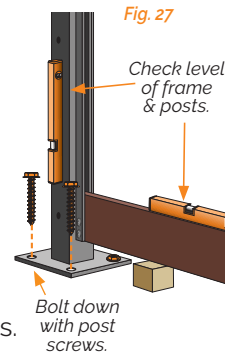

72" & 24" Slat Fence Kit

7. Insert Spacers

- Slide **Slat Spacers** into each channel from the top (Figs. 28 & 30) with extensions facing the post (Figs. 29 & 30).
- Stack **Spacers** to add spacing between slats in 1/2" increments (Fig. 31).
- Slide slats into channels to sit on top of **Spacers**, between the two side brackets (Figs. 28 & 32).

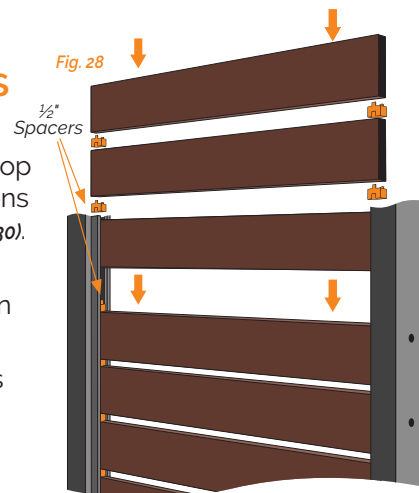

SLAT SPACERS

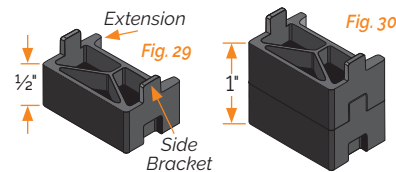
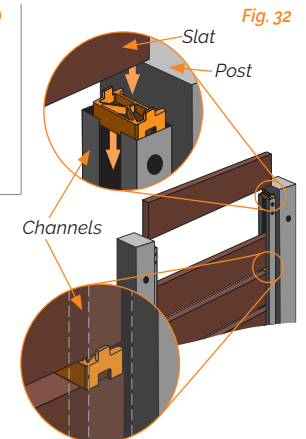
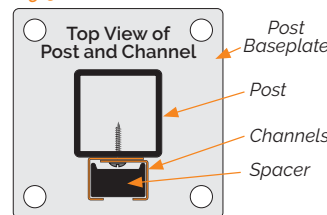

Fig. 30



8. Install & Secure Slats

72" Slat Fence Kit

- Continue adding slats and spacers until you've positioned a slat* at mid-point where the channel has pre-drilled holes.
- Repeat **Step 5**, pre-drilling into the mid-point slat (Figs. 25 & 33) and inserting **Slat Locking Screws** (Fig. 26).
- Continue adding slats and spacers to top of the channels.
- If slats do not fill to the top of channels, insert a Spacer at top to fill the space.*
- Repeat **Step 5**, pre-drilling into top slat* (Figs. 26 & 33) or spacer and insert **Slat Locking Screws**.

*Do not drill all the way through the slat. If top channel holes align with a spacer instead of a slat, you can drill and screw into the spacer.

Optional Brace Strap

(Read "Slat Materials" section on p. 2)

- Use to prevent warping or twisting of slats less than 3/4" or lower-grade woods. Not necessary for slats 3/4" or thicker in hardwoods such as tropical hardwood, cedar, and good-quality redwood.
- Attach the optional **Brace Strap** in the center of each fence section using the included **Brace Strap Screws** (Fig. 34).

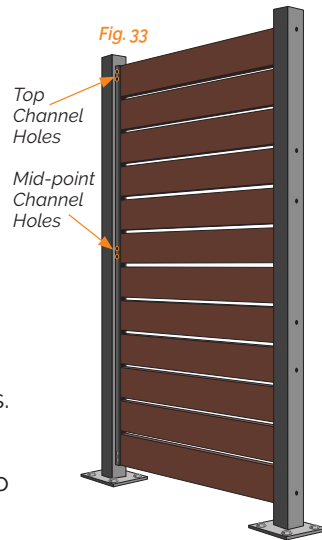

24" Slat Fence Kit

- Continue adding slats and spacers (Fig. 35) to the top of the lower channels (Fig. 36).
- If slats do not fill to the top of channels, insert a Spacer at the top to fill the space.*
- Repeat **Step 5**, pre-drilling into top slat* (Fig. 25) and inserting **Slat Locking Screws** (Fig. 26).
- Repeat **Step 3**, installing upper channels above lower set (Fig. 36).
- Repeat **Step 4**, adjusting channel widths (Fig. 24). Drive in screws securely. **Do not overtighten.**
- Repeat **Step 5**, pre-drilling into bottom slat of upper section (Fig. 25) and inserting **Slat Locking Screws** (Fig. 26).
- Fill slats and spacers to the top of the channels.
- Repeat **Step 5**, pre-drilling into top slat* in upper channels (Fig. 25) and inserting **Slat Locking Screws** (Fig. 26).

*Do not drill all the way through the slat. If top channel holes align with a spacer instead of a slat, you can drill and screw into the spacer.

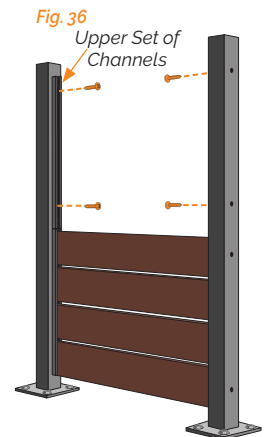
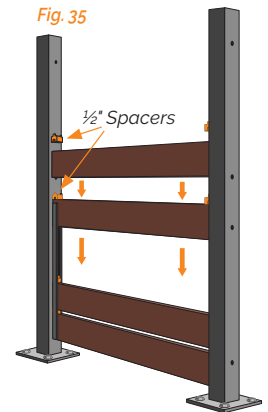

9. Finish Fencing

- Add extended linear sections or corner installations, repeat all steps, attaching channels to previous posts (See Fig. 5 on p.1 and Figs. 8 & 9 on p. 2).
- Once fencing is finished, insert **Post-Hole Plugs** (included with posts) into unused post holes to help prevent water leaking into posts (Fig. 37).

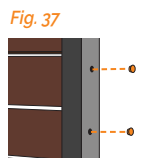

24" Slat & Panel Horizontal Installations

Combine Slat Fence Kits and Panel Frame Kits

Follow **24" Panel Frame Kits** instructions to assemble and install frames and panels. Then follow **24" Slat Fence Kit** instructions install channels and slats.

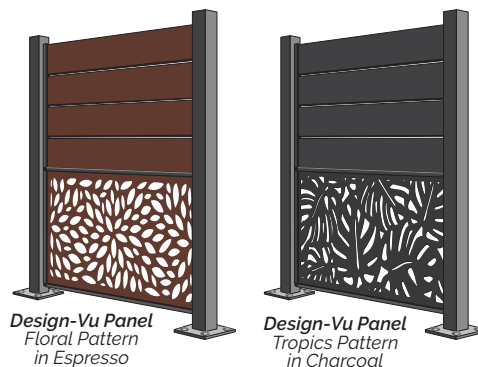
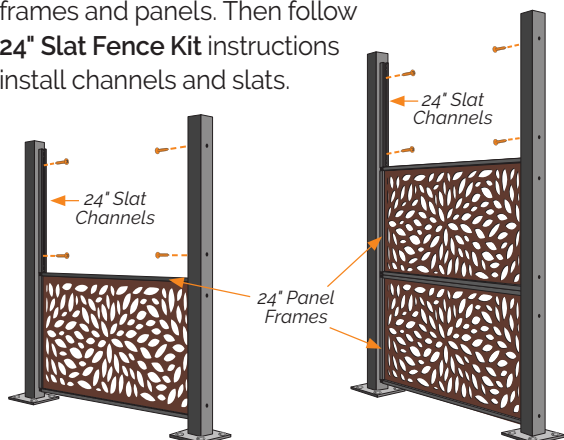

Each of the above: 1 - 24" Panel Kit + 1 - 24" Slat Kit + 2 - 52" Posts + 1 - 24" x 48" Decorative Panel



1 - 24" Panel Kit + 1 - 24" Slat Kit + 2 - 52" Posts + 2 - 24" x 48" Decorative Panels